

LUMENFLEX-TOP

Cable Entry

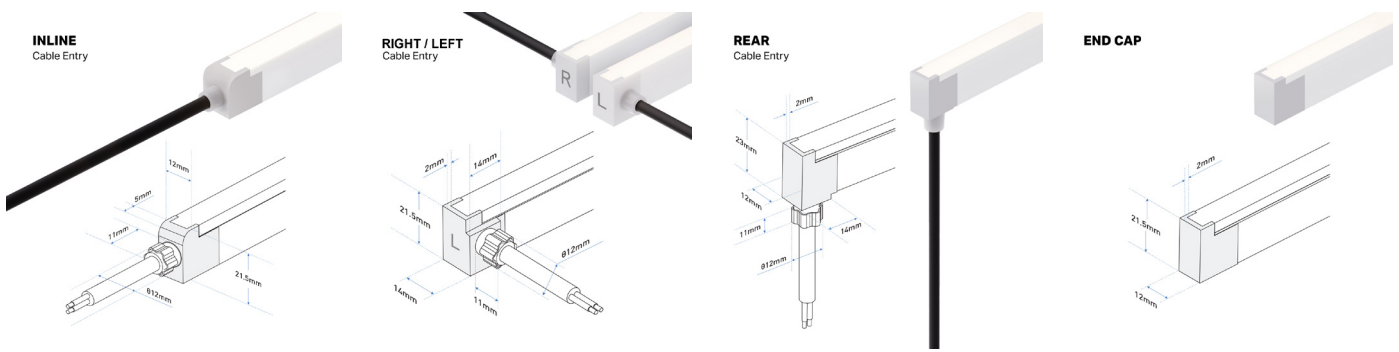

Mounting Profile Information

LF-TOP-HS - Standard Aluminium U Profile

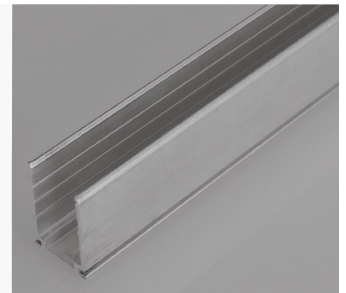
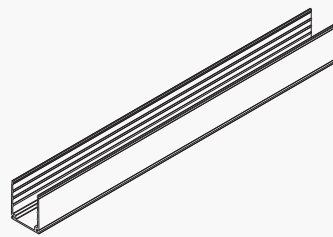
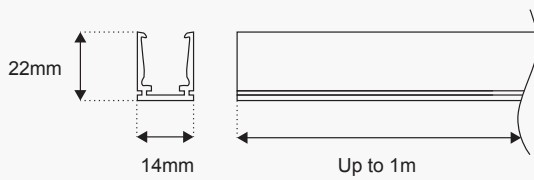

LF-TOP-HS-SL-BRACKET - Self-Locking Aluminium U Channel

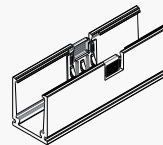
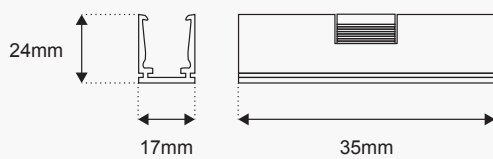

LF-TOP-HS-SL - Self-Locking Aluminium U Channel

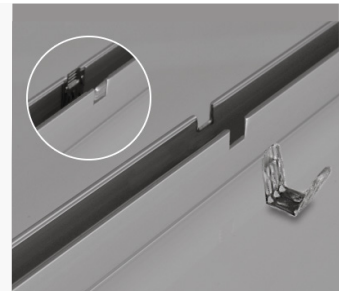
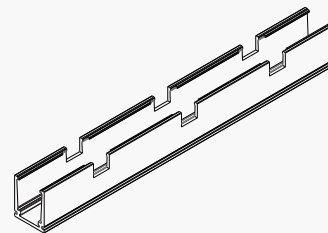
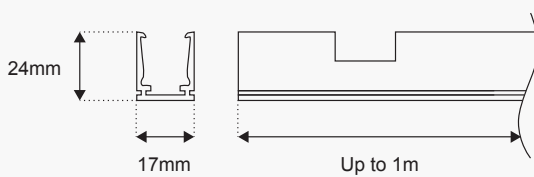

LF-TOP-HS-PLASTIC-WH - Standard Plastic U Profile - White LF-TOP-HS-PLASTIC-CL - Standard Plastic U Profile - Clear

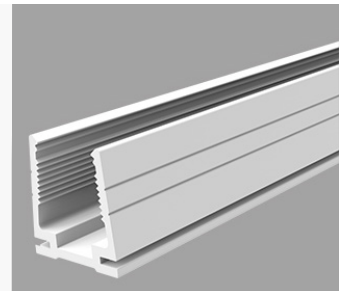
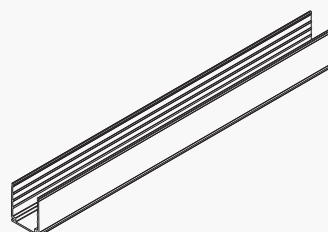
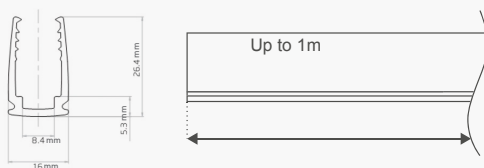

LUMENFLEX-TOP

Driver Configuration Table

BC Code	DRIVER (Non-Dim)	SPECIFICATION	LUMENFLEX LENGTH
15210	ORLRPV2435	LED Driver, DC24V, 35W	Up to 2.5M
15214	ORLRPV2460	LED Driver, DC24V, 60W	Up to 5M
15199	ORLRPV24100	LED Driver, DC24V, 100W	Up to 8M
15203	ORLRPV24150	LED Driver, DC24V, 150W	Up to 10M
BC Code	DRIVER (Mains Dim)		
15221	ORLRPV25-24MD	LED 25W Mains Dimmable Driver 24V	Up to 2M
15250	ORLRPV50-24MD	LED 50W Mains Dimmable Driver 24V	Up to 4M
15169	ORLRPV100-24MD	LED 100W Mains Dimmable Driver 24V	Up to 8M
15193	ORLRPV150-24MD	LED 150W Mains Dimmable Driver 24V	Up to 10
BC Code	INTERFACE		
15357	ORLRPV-INTERFACE-MINI	1-10V INTERFACE	Up to 10M
14054	ORLDALIINTERFACE-12/24/36V	DALI INTERFACE	Up to 10M

Length Matrix

The LUMENFLEX-TOP-MINI can be cut every 83.33mm. The below table gives information on the overall length, obtained by adding the total cable entry length and end mould, to all the available cut lengths up to 10M.

Note: Allow for a tolerance of +/- 0.3mm on cut points.

Segments	Luminaire/ Cutpoints	Total Length (mm)		
		Inline+End	Left/Right+End	Rear+End
1	83.33	101.33	87.33	87.33
2	166.67	184.67	170.67	170.67
3	250.00	268.00	254.00	254.00
4	333.33	351.33	337.33	337.33
5	416.67	434.67	420.67	420.67
6	500.00	518.00	504.00	504.00
7	583.33	601.33	587.33	587.33
8	666.67	684.67	670.67	670.67
9	750.00	768.00	754.00	754.00
10	833.33	851.33	837.33	837.33
11	916.67	934.67	920.67	920.67
12	1000.00	1018.00	1004.00	1004.00
13	1083.33	1101.33	1087.33	1087.33
14	1166.67	1184.67	1170.67	1170.67
15	1250.00	1268.00	1254.00	1254.00
16	1333.33	1351.33	1337.33	1337.33
17	1416.67	1434.67	1420.67	1420.67
18	1500.00	1518.00	1504.00	1504.00
19	1583.33	1601.33	1587.33	1587.33
20	1666.67	1684.67	1670.67	1670.67
21	1750.00	1768.00	1754.00	1754.00
22	1833.33	1851.33	1837.33	1837.33
23	1916.67	1934.67	1920.67	1920.67
24	2000.00	2018.00	2004.00	2004.00
25	2083.33	2101.33	2087.33	2087.33
26	2166.67	2184.67	2170.67	2170.67
27	2250.00	2268.00	2254.00	2254.00

Length Matrix

Segments	Luminaire/ Cutpoints	Total Length (mm)		
		Inline+End	Left/Right+End	Rear+End
28	2333.33	2351.33	2337.33	2337.33
29	2416.67	2434.67	2420.67	2420.67
30	2500.00	2518.00	2504.00	2504.00
31	2583.33	2601.33	2587.33	2587.33
32	2666.67	2684.67	2670.67	2670.67
33	2750.00	2768.00	2754.00	2754.00
34	2833.33	2851.33	2837.33	2837.33
35	2916.67	2934.67	2920.67	2920.67
36	3000.00	3018.00	3004.00	3004.00
37	3083.33	3101.33	3087.33	3087.33
38	3166.67	3184.67	3170.67	3170.67
39	3250.00	3268.00	3254.00	3254.00
40	3333.33	3351.33	3337.33	3337.33
41	3416.67	3434.67	3420.67	3420.67
42	3500.00	3518.00	3504.00	3504.00
43	3583.33	3601.33	3587.33	3587.33
44	3666.67	3684.67	3670.67	3670.67
45	3750.00	3768.00	3754.00	3754.00
46	3833.33	3851.33	3837.33	3837.33
47	3916.67	3934.67	3920.67	3920.67
48	4000.00	4018.00	4004.00	4004.00
49	4083.33	4101.33	4087.33	4087.33
50	4166.67	4184.67	4170.67	4170.67
51	4250.00	4268.00	4254.00	4254.00
52	4333.33	4351.33	4337.33	4337.33
53	4416.67	4434.67	4420.67	4420.67
54	4500.00	4518.00	4504.00	4504.00
55	4583.33	4601.33	4587.33	4587.33
56	4666.67	4684.67	4670.67	4670.67
57	4750.00	4768.00	4754.00	4754.00
58	4833.33	4851.33	4837.33	4837.33
59	4916.67	4934.67	4920.67	4920.67
60	5000.00	5018.00	5004.00	5004.00
61	5083.33	5101.33	5087.33	5087.33
62	5166.67	5184.67	5170.67	5170.67
63	5250.00	5268.00	5254.00	5254.00
64	5333.33	5351.33	5337.33	5337.33
65	5416.67	5434.67	5420.67	5420.67
66	5500.00	5518.00	5504.00	5504.00
67	5583.33	5601.33	5587.33	5587.33
68	5666.67	5684.67	5670.67	5670.67
69	5750.00	5768.00	5754.00	5754.00
70	5833.33	5851.33	5837.33	5837.33
71	5916.67	5934.67	5920.67	5920.67
72	6000.00	6018.00	6004.00	6004.00
73	6083.33	6101.33	6087.33	6087.33
74	6166.67	6184.67	6170.67	6170.67
75	6250.00	6268.00	6254.00	6254.00

Length Matrix

Segments	Luminaire/ Cutpoints	Total Length (mm)		
		Inline+End	Left/Right+End	Rear+End
76	6333.33	6351.33	6337.33	6337.33
77	6416.67	6434.67	6420.67	6420.67
78	6500.00	6518.00	6504.00	6504.00
79	6583.33	6601.33	6587.33	6587.33
80	6666.67	6684.67	6670.67	6670.67
81	6750.00	6768.00	6754.00	6754.00
82	6833.33	6851.33	6837.33	6837.33
83	6916.67	6934.67	6920.67	6920.67
84	7000.00	7018.00	7004.00	7004.00
85	7083.33	7101.33	7087.33	7087.33
86	7166.67	7184.67	7170.67	7170.67
87	7250.00	7268.00	7254.00	7254.00
88	7333.33	7351.33	7337.33	7337.33
89	7416.67	7434.67	7420.67	7420.67
90	7500.00	7518.00	7504.00	7504.00
91	7583.33	7601.33	7587.33	7587.33
92	7666.67	7684.67	7670.67	7670.67
93	7750.00	7768.00	7754.00	7754.00
94	7833.33	7851.33	7837.33	7837.33
95	7916.67	7934.67	7920.67	7920.67
96	8000.00	8018.00	8004.00	8004.00
97	8083.33	8101.33	8087.33	8087.33
98	8166.67	8184.67	8170.67	8170.67
99	8250.00	8268.00	8254.00	8254.00
100	8333.33	8351.33	8337.33	8337.33
101	8416.67	8434.67	8420.67	8420.67
102	8500.00	8518.00	8504.00	8504.00
103	8583.33	8601.33	8587.33	8587.33
104	8666.67	8684.67	8670.67	8670.67
105	8750.00	8768.00	8754.00	8754.00
106	8833.33	8851.33	8837.33	8837.33
107	8916.67	8934.67	8920.67	8920.67
108	9000.00	9018.00	9004.00	9004.00
109	9083.33	9101.33	9087.33	9087.33
110	9166.67	9184.67	9170.67	9170.67
111	9250.00	9268.00	9254.00	9254.00
112	9333.33	9351.33	9337.33	9337.33
113	9416.67	9434.67	9420.67	9420.67
114	9500.00	9518.00	9504.00	9504.00
115	9583.33	9601.33	9587.33	9587.33
116	9666.67	9684.67	9670.67	9670.67
117	9750.00	9768.00	9754.00	9754.00
118	9833.33	9851.33	9837.33	9837.33
119	9916.67	9934.67	9920.67	9920.67
120	10000.00	10018.00	10004.00	10004.00

NOTE: The max length power from one side is 10 meters. The overall lengths are including Ends, please also allow for +/- 0.3mm Tolerance on overall length. Products are injection moulded by machine that is man operated therefore please allow a tolerance of 5mm.