

# MAXDR-MINI-140MA

ITEM NO. DRIVER - 22247

MAXDR-MINI-140mA is a constant current LED driver. Featuring DALI-2, Push-DIM and 1-10V.

Input: 220-240VAC ~ 50-60Hz  
Output: 100-380mA

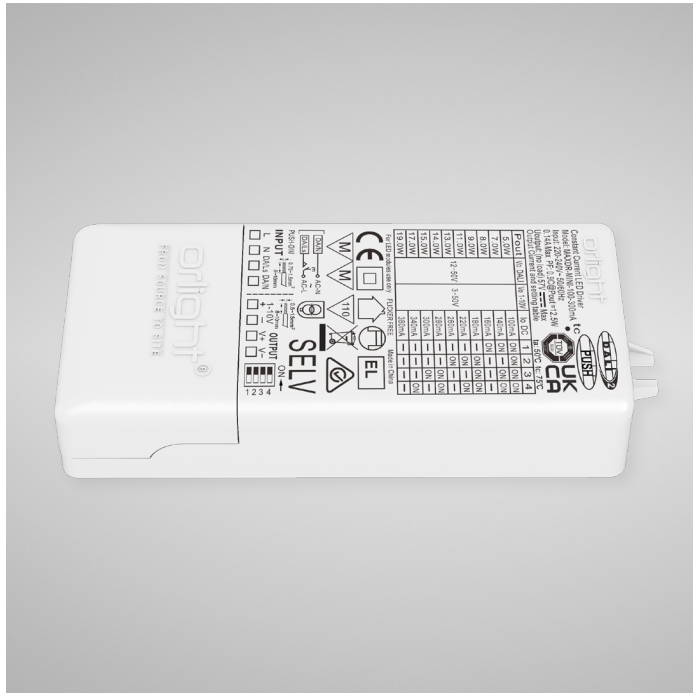

## Dimension

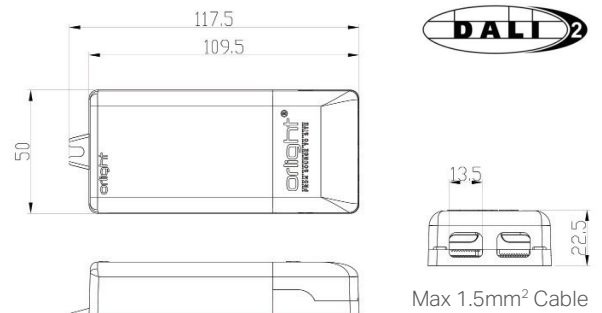

## Technical Specifications

Dimming Options	DALI; Push-DIM; 1-10V
Type	Constant Current
Input Voltage	220-240VAC
Input Frequency	50-60Hz
In-Rush Current	16A @ 30μs
Output Voltage	57V Max (NO LOAD)
Lifetime	>50,000 hours
IP Rated	IP20
Ta	-20°C ~ +45°C
Tc	85°C
THD	<10%
Glow Wire Test	850°C for 5S; 650°C for 30S

### DALI Standard

IEC 62386-101: 2014. IEC 62386-102; 2014,  
IEC 62386-207: 2009, DALI-2

### Flicker

Output P\_ST\_LM [at full load] ≤ 1  
Output SVM [at full load] ≤ 0.4

Pout	Forward Vo DALI	Forward Vo 1-10V	Io DC	Dip Switch 1	Dip Switch 2	Dip Switch 3	Dip Switch 4
5.0W	12-50V	3-50V	100mA	ON	ON	ON	ON
7.0W			140mA	ON	—	ON	ON
8.0W			160mA	ON	—	—	—
9.0W			180mA	—	ON	ON	ON
11.0W			220mA	—	ON	—	ON
13.0W			260mA	—	ON	—	—
14.0W			280mA	—	—	ON	ON
15.0W			300mA	—	—	—	ON
17.0W			340mA	—	—	—	ON
19.0W			380mA	—	—	—	—

# MAXDR-MINI-100MA

## Circuit Diagram: DALI

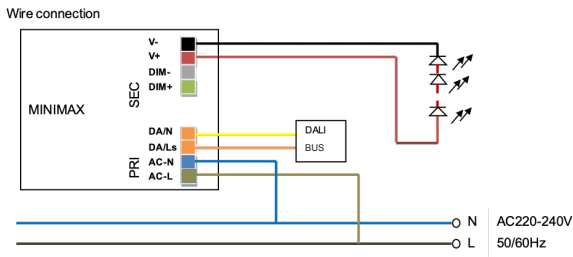

Compatible with both DALI-2 application controllers or DALI-1 master.

DALI signal to the DA1 and DA2 terminals are polarity-free.

Addressing:

- Max 64 IP addresses.
- Max. 16 Groups
- Dimming Range 1-100%

## Circuit Diagram: 1-10V

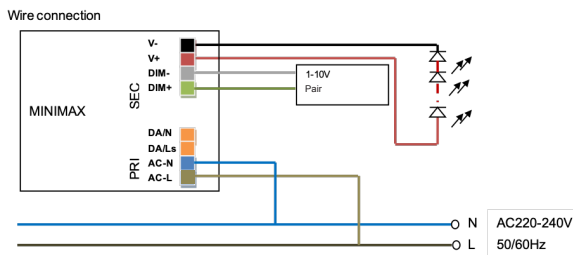

Compatible with both passive and active 1-10V dimmers.

Connect the 1-10V Master as per wire schematic, then you can dim using a 1-10V dimmer.

The maximum permissible length of the control line is 100M.

## Circuit Diagram: Push-DIM

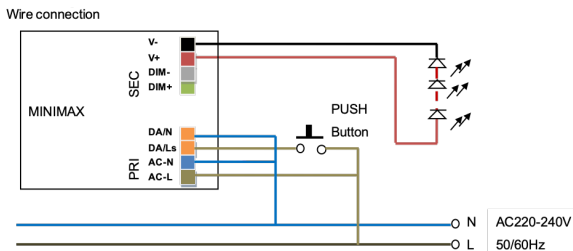

Do not use more than 20 MAXDR-MINI-100-380mA in a single push-DIM application.

B) The cable length between the push-button and the farthest MAX-DR-MINI may not be longer than 105M. Compensation measures must be applied for line lengths required to be more than 25M long.

Operation	Action Duration	Action
Briefly Press	0.04-0.5 sec	Light ON/OFF
Press & hold at ON status	0.50-5.0 sec	Brightness Dimming down to 2%, or up to 100%
Press & hold at OFF status	0.50-5.0 sec	Brightness Dimming from 2%, up to 100%

## Parallel Wiring

DALI

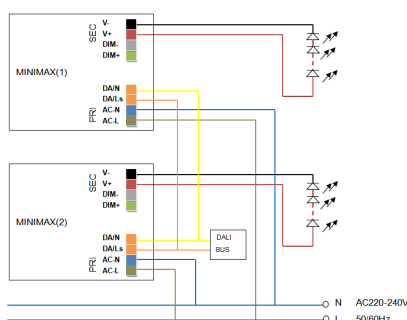

1-10V

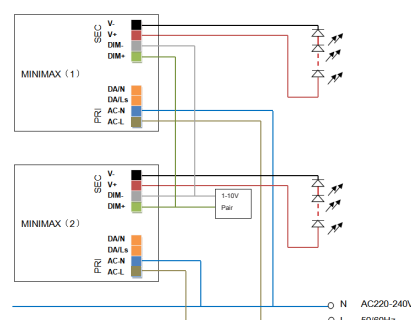

PUSH DIMMING

